

Keyboard controller Users Manual

Copyright(c)2008



This manual might be not accurate technically or contains some minor typo errors. The contents in this manual about production description and program might be updated on an un-periodical.

Cautions:

- § The LCD is fragile, no crush or long-exposed under strong light.
- § Operation knob is fragile, please make sure product is packed with original packing material when you send it back for repairation.
- § The keyboard controller should be work in specified range of temperature and humidity.
- § Please follow the connecting method defined in this manual.

keyboard controller parametersa:

| Item | Parameters |
|---------------|--|
| Power supply | DC12V ± 10%/50HZ |
| Temperature | -10 ~ 55°C |
| Humidity | ≤ 90% RH (No cream node) |
| Communication | RS485 Half-duplex |
| Baud Rate | 1200bps、2400bps、4800bps、9600bps、19200bps |
| Interface | 5PIN Pressure Line Terminal |
| That way | The LCD screen |
| Exterior size | 305 (L)X148 (W)X82 (H)mm |

List of items :

| Name | Quantity | Units | Remarks |
|-------------------|----------|-------|------------------------------|
| 5PIN Isobar plugs | 1 | PCS | |
| DC-12VPower | 1 | PCS | INPUT : 100-240VAC ~ 50/60Hz |
| 《Users Manual》 | 1 | PCS | |

Foreword

| | |
|--|----|
| Preface | 5 |
| Front board and back board introduction | 6 |
| 1.1 Function keys on front keyboard controller | 6 |
| 1.2 The LCD screen | 7 |
| 1.3 Operation knob control | 8 |
| 1.4 Introduction to the connection part of keyboard controller | 8 |
| Introduction to control keyboard controller operations | 9 |
| 2.1 Introduction to single key and combined keys | 9 |
| 2.2 Detailed introduction to combined keys | 9 |
| keyboard controller parameter Setup and inquiry | 12 |
| 3.1 Keyboard controller protocol and Baud rate Setup | 12 |
| 3.2 Keyboard controller system parameter Setup | 13 |
| 3.3 Keyboard controller parameter Setup framework | 14 |
| 3.4 Keyboard controller parameter inquiry | 15 |
| 4: Typical connecting diagram | 16 |
| 5: FAQs | 17 |

Keyboard controller introduction

Keyboard controller is a requisite device for compact monitor system, which controls the positioning of all front speed domes, mounting bracket and electric lens, and also the out-door shield brush, auxiliary lamp.

Usually keyboard controller consists of many number keys and function keys. Number keys are used to control speed domes or decoder. Function keys are used to control front devices. LCD on console display control codes and working status of each monitor station.

One system has only one master control board, but many slave control board, which are usually located in the respective office to achieve remote control of the entire tele monitor control system.

Features of keyboard controller

- ★ Devices connected to RS485 bus can be set with different protocol and baud rate .
- ★ Update new program on line. According to the protocol and control codes provided by customer, compile update program. Customer can update firmware by connecting to keyboard controller to computer via RS485 bus.
- ★ One key to retrieve the protocol and baud rate of current control address.
- ★ All parameters can be set via control key operations.

Basic function of keyboard controller

- * RS485 control bus can control maximum 255 front devices(depending on the setting of communication chipset)
- * Standard RS485 I/O ports are all lightning-proof, strong for interference. Standard communication distance is as long as 1200m.
- * Uplink port can provide links to maximum 15 slave keyboard controllers.
- * Multiple protocol available for speed dome control.
- * Password to lock/unlock keyboard controller.
- * Key sound ON/OFF
- * Progressive speed dome control
- * LCD display, multi-dimension control knob control

Front board and back board introduction

1.1 Function keys on front keyboard controller

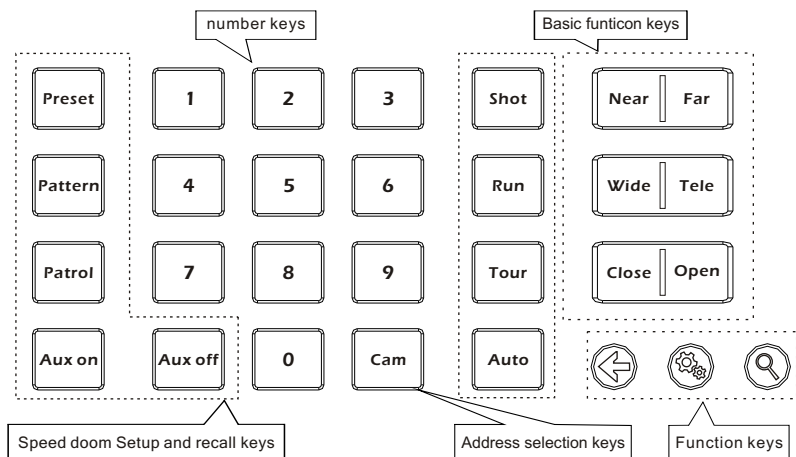

Function keys:

- 【←】 Back to previous menu and esc .
- 【⚙️】 Press for 3sec to set up key parameters and enter .
- 【🔍】 Inquire The Protocol & Baud Rate Of Current Address .

Speed doom Setup and recall keys:

(this function might be not available for part of protocols if the speed doom does not have this function)

- 【Preset】 Preset the original position of speed doom. This key should be used together with number key .
- 【Pattern】 Start/Esc to pattern record of speed doom, pressing for 3S to record pattern, and end to record pattern pressed again. This key should be used together with control knob or function key.
- 【Patrol】 Start/Esc to patrol record of speed doom, press this key to Enter patrol set, and Esc to patrol set press this key again. This key should be used together with control knob or function key.

- 【Aux on】** AUX key turns on. Turn on AUX key. This key should be used together with number key.
- 【Aux off】** AUX key turns off. Turn off AUX key. This key should be used together with number key .
- 【Shot】** Recall the preset position of speed doom. This key should be used together with number key .
(Some special function are achieved via recalling preset, e.g. Recall speed doom menu, recall integrated menu, pattern patrol, pattern scan, linear scan, et.)
- 【Run】** Recall the stored PATTEN. This key should be used together with number key .
- 【Tour】** RUN speed doom patrol according to speed doom in memory. This Key should be used with number key .
- 【Auto】** Control speed doom Automatically

Number keys:

- 【0】 ~ 【9】** number Key: 0、1、2、3、4、5、6、7、8、9.
- 【Cam】** Address selection key. Select decoder address, PTZ address.

Basic keys for speed doom and decoder:





- 【Near】** Manual focus on distant object.
- 【Far】** Focus on closer object ,
- 【Tele】** Zoom in to object, i.e enlarge object.
- 【Wide】** Zoom out the lens to larger view field.
- 【Open】** Increase aperture manually.
- 【Close】** Downsize aperture.

1.2 The LCD screen





All key operations will be displayed on LCD instantly. LCD will switch to Low-Power mode if the smart controller does not receive any input for more than 30 seconds. Screen will return to the initial state

1.3 Operation knob control





When control speed doom and mounting plate:

| | | | | | | | |
|---|----------------|---|----------------|---|----------------|---|----------------|
| Operating | Output Control | Operating | Output Control | Operating | Output Control | Operating | Output Control |
|  | Upward |  | Downward |  | Left |  | Right |

When control Setup of keyboard controller:

| | | | | | | | |
|---|----------------|---|------------------|---|-----------------------|---|------------------------|
| Operating | Output Control | Operating | Output Control | Operating | Output Control | Operating | Output Control |
|  | Menu turned up |  | Menu turned down |  | Parameter of the left |  | Parameter of the right |

When control menu for speed doom:

| | | | | | | | |
|---|----------------|---|----------------|---|---------------------|---|-----------------|
| Operating | Output Control | Operating | Output Control | Operating | Output Control | Operating | Output Control |
|  | Upward |  | Downward |  | Esc or not save set |  | Esc or save set |

1.4 Introduction to the connection part of keyboard controller

Backboard : 1 5-pin port, 1 DC-12V port, 2 LED indicator:

The following map:

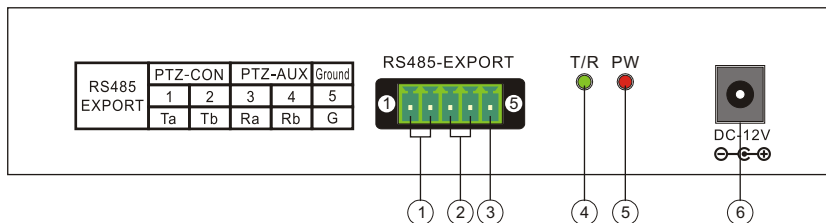

Detailed functions of each portion:

| Item | Marked | Interface | Description |
|------|---------|------------------------|---|
| ① | PTZ-CON | Control output (Ta/Tb) | Connect to speed doom RS485 bus(Ta)to RS485+,(Tb) to RS485- |

| | | | |
|---|---------|--|--|
| ② | PTZ-AUX | Slave keyboard controller input (Ra, Rb) | Connect to slave key port: Ra to Ta on slave , Rb to Tb on slave |
| ③ | Ground | Grounding(G) | grounding of communication cable |
| ④ | T/R | PTZ indicator | Display output status: Flickering and GREEN |
| ⑤ | PW | Power indicator | Always on, RED |
| ⑥ | DC-12V | DC power input | DC power input |

Introduction to control keyboard controller operations

2.1 Introduction to single key and combined keys

2.1.1 Single key: When single key is pressed, the corresponding PTZ will respond.

Single key operations include: **【Near】**、**【Far】**、**【Tele】**、**【Wide】**、**【Open】**、**【Close】**、**【Auto】** and control knob

2.1.2 Combined key operations mean 2 or more keys, or key and knob are pressed, the corresponding PTZ will respond.

The operations include **【Preset】**、**【Pattern】**、**【Patrol】**、**【Shot】**、**【Run】**、**【Tour】**、**【Cam】**、**【Aux on】**、**【Aux off】**

2.2 Detailed introduction to combined keys

2.2.1 Enter PTZ mode:

If LCD display **PTZ-XXX**, indicating the control key board is working in PTZ mode, if no, please **【↵】** to back to PTZ mode.

2.2.2 Choose PTZ address:

In PTZ mode, press corresponding addr and input the PTZ address number to control, then press **【Cam】** .

E.g. To control PTZ code 28,

Operation: Press **【2】** **【8】** , LCD will display: **PTZ-001 28**

Press **【Cam】** , LCD will display : **PTZ-028**

2.2.3 Set and recall pattern scan:

Setup: Choose the address to set pattern scan . Then press by long time **【Pattern】** key, the LCD will display: **PATTERN RECORD** ; Part of an agreement to set a number of pattern scan, press number and **【Pattern】** , LCD will display: **PATTERN RECORD** ;

Operate the control knob to stop or remain at certain position or zoom in/out lens, etc.

After Setup is complete, press **【Pattern】** to stop recording pattern again, and LCD will display: **PATTERN STOP** .

Recall: Press **【Run】** , LCD will display: **RUN PATTERN NO:** ; The speed doorm will operate per the 1st pattern, LCD display: **PTZ-XXX PATTERN**

Run any single key operation will stop pattern scan and back to normal status.

Notes: There is only one a pattern of PELCOD, PELCOP protocols. Press **【Pattern】** for 2S when set pattern firstly, and the other operations is same as operations of pattern of the other protocols.

2.2.4 Set and recall patrol:

Setup: Choose the address code of speed doorm to set patrol. Then press number key and **【Patrol】** key

E.g. if we want to set the 1st patrol, press **【1】** and **【Patrol】** , LCD display: **NO:1 PRESET: 001** (Indicating we are setting the 1st preset point of No.001 patrol), move knob leftwards or rightwards to choose which preset point added to the track of this patrol.

Move knob downwards, LCD will display: **NO:1 PRESET +001** (indicating the 1st preset added in the 1st patrol). LCD will display: **P:001 TIME:003** , move knob leftwards or rightwards to change the time of staying this preset point.

Move knob downwards, LCD will display: **P:001 TIME:+003** (indicating the stay time of 1st preset point is 3S), Move knob rightwards, LCD will display: **P:001 SPEED:01** (the move time from one preset point to another), move knob leftwards or rightwards to change the move time from one preset point to another.

Move knob downwards, LCD will display **NO:1 PRESET:002** . Repeat the above operations till Setup is completed. When Setup is complete, press **【Patrol】** key, LCD will display: **SAVE PATROL SET?** , and press **【⚙️】** to memory and back, press **【↩️】** not to save and back.

Recall: Press **【1】** and **【Tour】** , LCD display : **PTZ - 001 PATROL** .

Run any single key operation will exit patrol and back to normal status.

Notes:

- 1: Leftwards or rightwards of knob is selected value of function, downwards of knob is Entered and go on to next a function.
- 2: In Setup process, press **【↩️】** to exit Setup.
- 3: Time of all patrol of YAAN is same, so first item is time of Setup. Speed of patrol is default.
- 4: Time and speed of all patrol of RULE is same, so first item is time of Setup and second item is speed of Setup.

2.2.5 Set and recall preset point:

Set up: Choose the address of speed doom to set or recall. Operate knob to move to corresponding point, and zoom lens to specified position, then press the preset point # to set, e.g 6, press 6 and **【Preset】** , LCD display : **PRESET: 6** , if you want to continue to set more, repeat the above operations .

Recall: Press number key and **【Shot】** , e.g **【6】** , then press **【Shot】** , **SHOT: 6** , to recall more repeat the above operations.

2.2.6 Turn on/off AUX:

Turn on: Choose the address of speed doom or decoder to turn on. Then press number key and **【Aux on】** , e.g turn on the AUX #1, press **【1】** and **【Aux on】** .

Turn off: Press number key and **【Aux off】** , e.g turn off AUX #1, press **【1】** and **【Aux off】** .

Note: The above combined key might be no available form some protocols, or some products do not have this function. Therefore, some operations might not work on some devices. If you have similar problems, please refer to the manual of device to achieve some specific function.

2.2.7 keyboard controller lock:

This function is to manage keyboard controller via password to allow authorized user to operate. This function must be activated in keyboard controller setting menu. Refer to details in 3.1.2.2.

In normal mode, press 【↵】 , LCD display: `LOCK PW: ----` ,

Input 4-digit password, press 【⚙️】 , LCD display : `LOCKED` ,
indicating the keyboard controller is locked.

Press any key, LCD display: `OPEN LOCK: ----` ,

Input password, press 【⚙️】 , the keyboard controller will be unlocked.

keyboard controller parameter Setup and inquiry

3.1 Keyboard controller protocol and Baud rate Setup

E.g. To set protocol of address 28 as PelcoP, Baud rate 9600.



The operations are:

In normal mode press 【⚙️】 for 3sec, LCD will display: `PASSWORD ----` ,

Input password(default 8888), press 【⚙️】 , LCD display : `>PTZ SETUP`

Press 【⚙️】 , LCD display : `>ADDRESS: 001` ,

Press 【2】 , 【8】 and 【⚙️】 key, LCD display: `PROTOCOL: PELCO P` ,







Move knob leftwards, LCD display : `PROTOCOL: PELCOF` ,
Press **【】** , buzzer rings, LCD display : `SETUP SUCCESS` ,
Move knob downwards, LCD display : `BAUD RATE: 2400` ,
Move knob rightwards, LCD display: `BAUD RATE: 9600` ,
Press **【】** , buzzer rings, LCD display: `SETUP SUCCESS` ,
After Setup is completed, press **【】** for 3 times to back to normal mode.

Note: To set the same protocol and baud rate for front device, Enter this screen `>ADDRESS: 0-254` , Then set the protocol and baud rate.



3.2 Keyboard controller system parameter Setup

System parameters include password, restore default settings, key tone ON/OFF, key ID Setup, keylock, etc. We will describe the Setup process by taking restoring default settings and key lock as examples.

3.2.1 Restore default settings

In normal mode, press **【】** for 3 sec, LCD display: `PASSWORD ----` ,
Input password(default 8888), press **【】** , LCD display: `>PTZ SETUP` ,
Move knob downwards, LCD display : `>SYSTEM SETUP`
Press **【】** , LCD display: `>SET PW`
Move knob downwards, LCD display: `>DEFAULT`
Press **【】** , LCD respond: `SURE?`
Press **【】** again, buzzer rings, LCD display: `SETUP SUCCESS` 1s,
Restore default settings successfully(to abort the process, press **【】** for 2 times to back to normal mode).

3.2.2 Keyboard controller lock ON/OFF

In normal mode, press **【】** for 3sec, LCD display: `PASSWORD ----` ,
Input password(default 8888), press **【】** , LCD display: `>PTZ SETUP` ,
Move knob downwards, LCD display: `>SYSTEM SETUP` ,
Press **【】** , LCD display: `>SET PW` ,
Move knob upwards, LCD display: `>LOCK SET` ,

Press **【】** , LCD display: **LOCK OFF** ,

Indicate the status of key lock.



Move knob rightwards, LCD display: **>LOCK ON** ,

Press **【】** , LCD display: **LOCK PW: ----** ,

Input 4-digit password, press **【】** , LCD display: **>LOCK SET** ,

Press **【】** for 2 times, exit Setup and back to normal mode.

3.3 Keyboard controller parameter Setup framework

| | | | |
|---------------|---------------|---|--|
| >PTZ Setup | >Address: XXX | PROTOCOL | PELCOD、PEL COP、RULE, etc |
| | | Baud Rate | 1200、2400、4800、9600、19200 |
| | >Cam: 0-254 | PROTOCOL | PELCOD、PEL COP、RULE, etc |
| | | Baud Rate | 1200、2400、4800、9600、19200 |
| >SYSTEM Setup | >Set PW | Old PW: | Figure 4 |
| | | New PW: | Figure 4 |
| | | Again PW: | Figure 4 |
| | > Default | Sure? | 【】 Confirmed, 【】 Withdrawal |
| | >Sound Set | Sound on | Knob about choice |
| | | Sound off | Knob about choice |
| | > ID Set | KEYBOARD ID | number 【0】 - 【15】 |
| | >Lock Set | Lock off | Knob about choice |
| Lock on | | 【】 , Enter a password state | |

3.4 Keyboard controller parameter inquiry

In normal mode, press 【 Q 】 to inquiry about keyboard controller status
keyboard controller parameter framework

| | | | |
|------------------|---|---|---------------------------------------|
| P: xxxxx B: xxxx | The agreement addresses the control and baud rate | | |
| >PTZ Search | >Address: 001 | PROTOCOL | Address correspond- ence agreement |
| | | Baud Rate | Address correspond- ence Baud Rate |
| >SYSTEM Search | KEYBOARD ID: XX | Two of the keyboard controller ID | |
| | SYS SN: XXXXXXXXX | 8 fuselage numbers | |
| | MODEL :XXXXXXXXXX | Ten of the largest Model | |
| | LOCK XXX(ON/OFF) | That set up the current situation Keyguard | |
| | SOUND XX(ON/OFF) | Keys tone that the current settings of | |

Typical connecting diagram

4: Typical connecting diagram

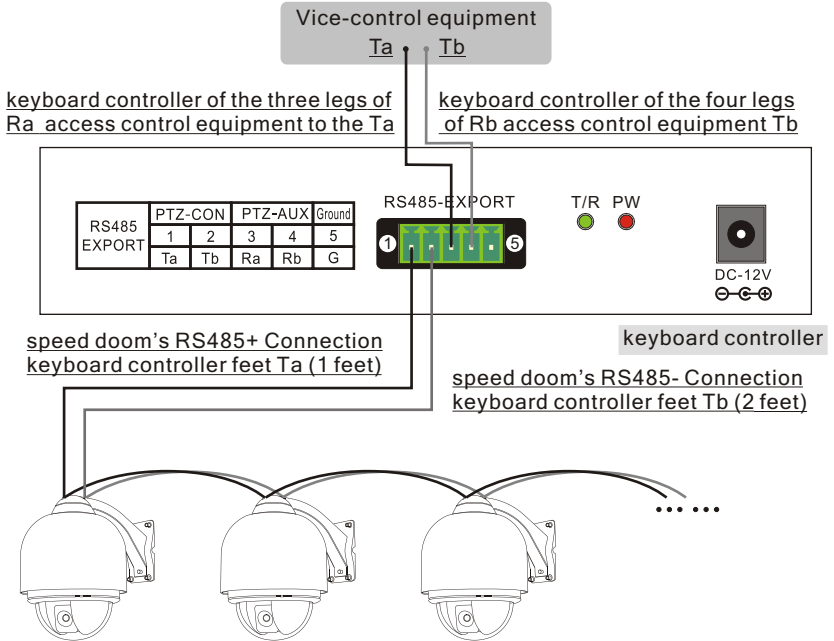

Introduction:

- Control code output: speed dome's RS485+ should be connected to Ta of keyboard controller, RS485- to Tb. Uplink control: Ra of keyboard controller to Ta of slave device, Rb to Tb.
- Vice-control equipment: keyboard controller, Rs485 output.

Function features: Both master keyboard controller and other slave devices can control the speed dome, to enable customer to enjoy remote control and the easy on-site operations

5: FAQs

Symptom: keyboard controller cannot control the speed doom.

Analysis 1: check the hardware: RS485.

Methods: Step 1: RS485 A and B is reversed.

Step 2: Check RS485 cable continuity is OK or not.

Analysis 2: Check the software settings: keyboard controller and speed doom address, protocol, baud rate.

Methods: Step 1: Press 【 Q 】 to check the current protocol and baud rate is correct or not.

Step 2: Restore the settings to default setting and reset.

Analysis 3: Check PTZ LED will flicker or not when communicating with speed doom.

Methods: Step 1: If PTZ LED flickers, the keyboard controller is free of problems.

Step 2: If PTZ LED does not flicker when communicating, the RS485 port might be defective.

Symptom: Slave device cannot control speed doom.

Analysis 1: Check hardware RS485 cable.

Methods: Step 1: Check RS485 A and B is reversed or not.

Step 2: Check RS485 cable continuity is OK or not.

Analysis 2: Check the AUX LED on master keyboard controller will flicker or not when communicating.

Methods: If PTZ LED flickers, then the settings of slave device might be the problem. Please check address, protocol and baud rate.

Symptom: Some speed dooms can be controlled but some not.

Analysis 1: Check hardware

Methods: Check the continuity of each branch cable

Analysis 2: Check software settings

Methods: Check the protocol and baud rate of each address code.

Analysis3: Might be the connecting diagram

Methods: Step 1: connect to RS 485 a 120 Ω at far end.

Step 2: Install RS485 hub at the connect of figure star.

Symptom: One operation of keyboard controller, a few speed dooms respond simultaneously.

Analysis : Check the address code of front device.

Methods: Check whether those speed doom that respond simultaneously have the same address code or not. Set different address.

Symptom: Forget key lock password.

Methods: In any status, press Setup till system setting menu appear, reset password.

Symptom: No key tone.

Methods: Turn on key tone in system settings.

